

THE PROPERTY OF THE DRAWING IS ESTABLISHED BY LAW. IT IS FORBIDDEN TO PRODUCE OR SHOW IT TO THIRD PART. WITHOUT A WRITTEN AGREEMENT.

Item	Name	Q.ty
1	CA.08.01.006	1
2	CA.08.09.003	1

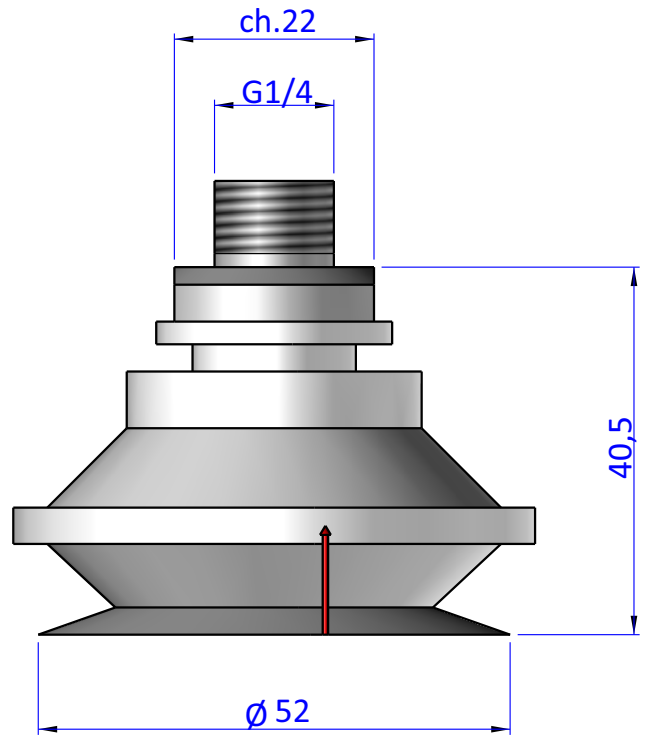
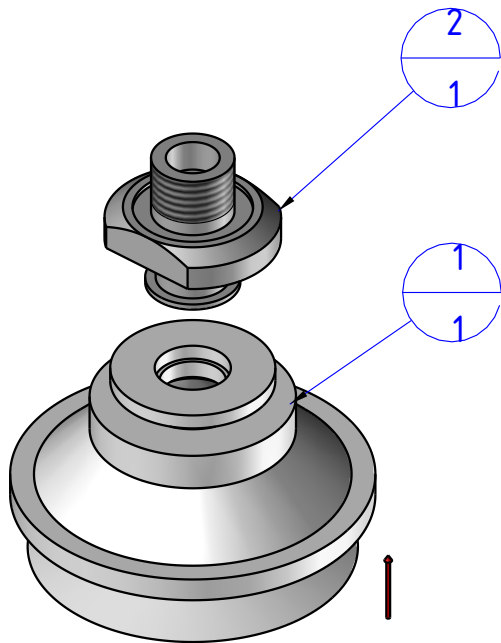

DESIGNED FROM FPS Automation		REVIEW A
DATE 03/11/2020	WEIGHT 0,031kg	
CODE KIT.08.01.D50.3		

Format **A4**

UNI 936-76

GENERAL TOLERANCE

UNI - ISO 2768

CLASSE f

DESCRIPTION

KIT.08.01.D50.3